

Plafonerie / Ceiling lamp

Cyber

Cilindro fisso per il soffitto, orientabile per soffitto o parete.

A fixed cylinder for the ceiling, rotating for the ceiling or wall.

Materiali / Materials

Alluminio

Aluminium



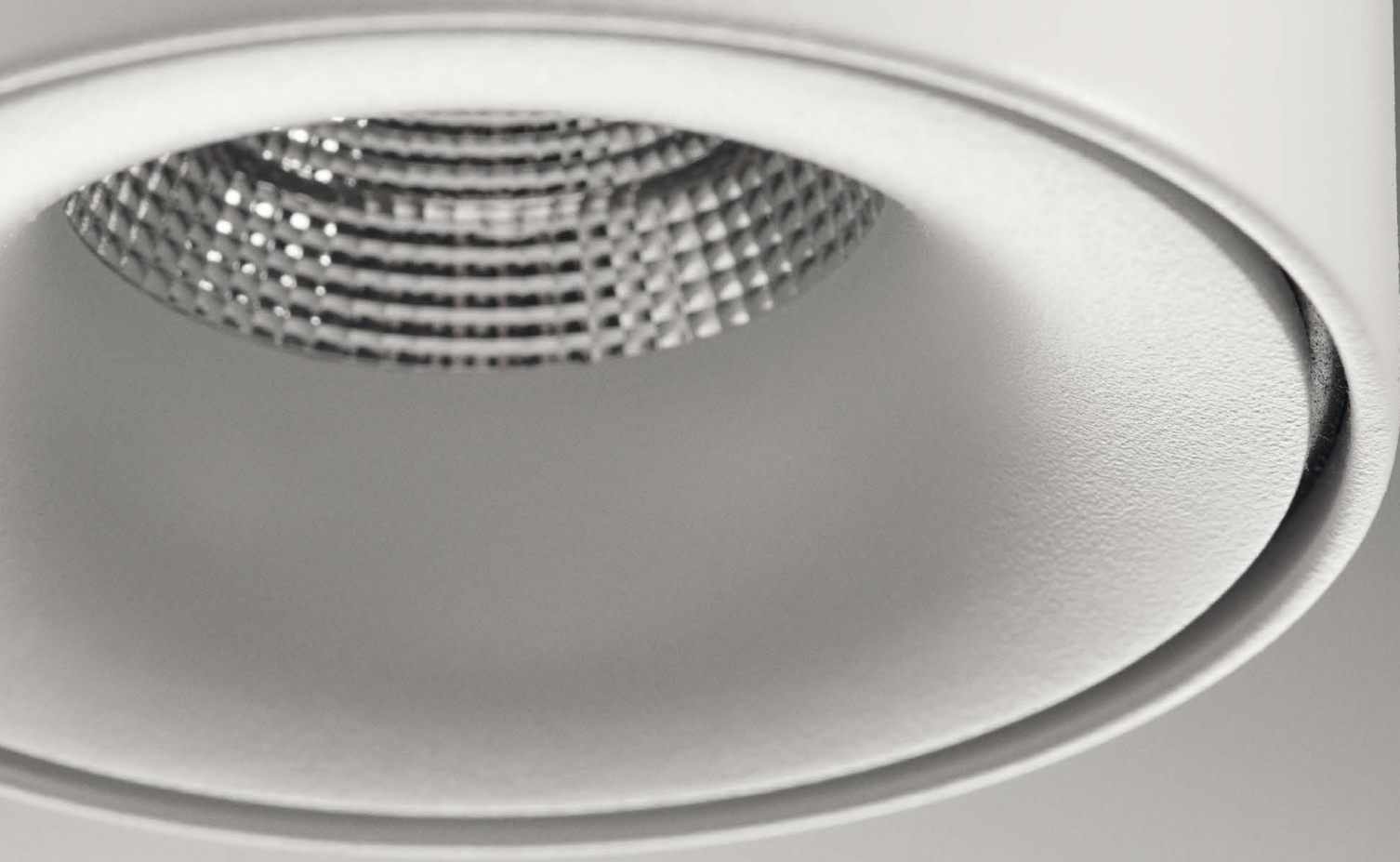

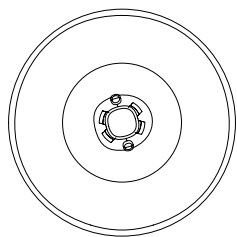

Ø 9cm

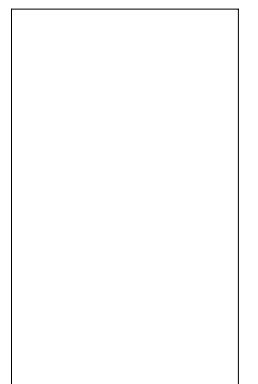

15cm

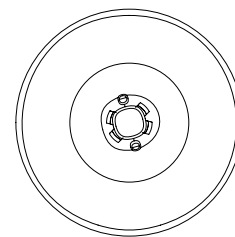

Ø 9cm

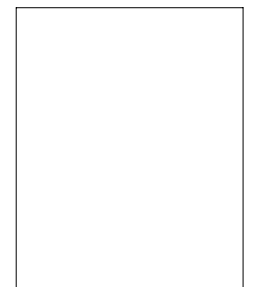

11,2cm

	vattaggio/wattage	kelvin/colour temperature
0008.20	11,5 W	3.000 K
lumen	materiale / material	
870 lm	Alluminio	Aluminium

	vattaggio/wattage	kelvin/colour temperature
0008.21	7,5 W	3.000 K
lumen	materiale / material	
635 lm	Alluminio	Aluminium



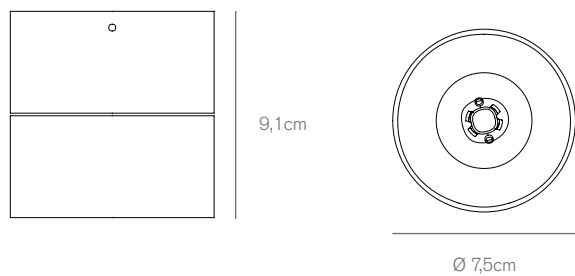

	vattaggio/wattage	kelvin/colour temperature
0008.24	9,3 W	3.000 K
lumen	materiale / material	
945 lm	Alluminio	
	Aluminium	

111

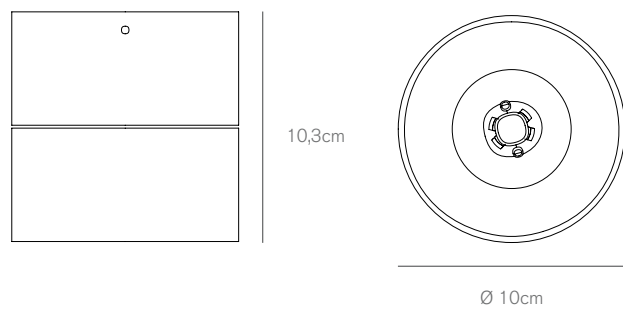

	vattaggio/wattage	kelvin/colour temperature
0008.22	11,5 W	3.000 K
lumen	materiale / material	
870 lm	Alluminio	
	Aluminium	

	vattaggio/wattage	kelvin/colour temperature
0008.23	16 W	3.000 K
lumen	materiale / material	
1.474 lm	Alluminio	
	Aluminium	